

Article number: 2311011382

Description: E+G Column level indicator
HCZ.76

Measures

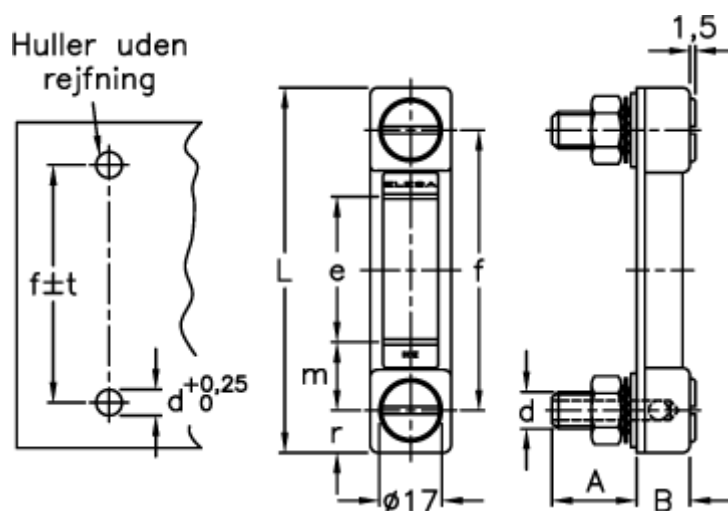

A = 23	Max tightening torque (Nm) = 12 to 15
B = 14.5	r = 11.5
C = 22	t = +/-0,5
d = M10	
e = 40	
f = 76	
L = 99	
m = 18	